

NOTES:

- 1.HUOSINGI:PA46 HIGH-TEMP THERMOPLASTIC UL94V-0 COLOR:WHITE
- 2.TERMINAL:PHOSPHOR BRONZE C5191
- 3.CODING INFORMATION: BB161-GXX-XOR

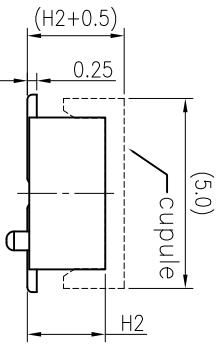

(MATING HEIGHT)

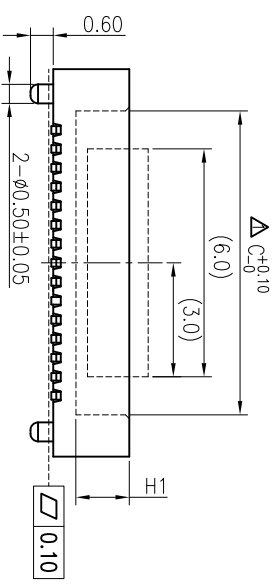
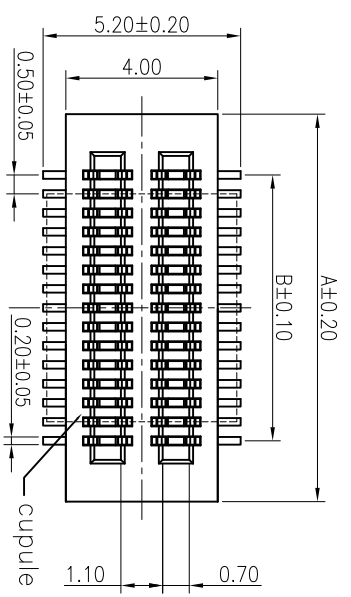
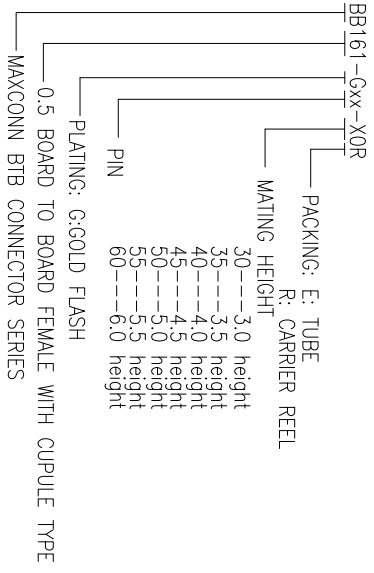
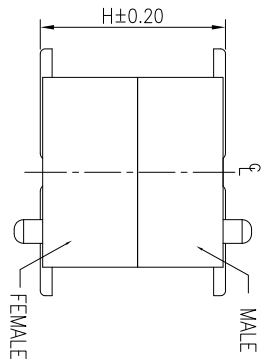

MATING HEIGHT	3.0	3.5	4.0	4.5	5.0	5.5	6.0	6.5
FEMALE H1	1.40							
FEMALE H2	2.05							
MALE H1	0.85	1.35	1.85	0.95	1.45	1.95	2.45	2.95

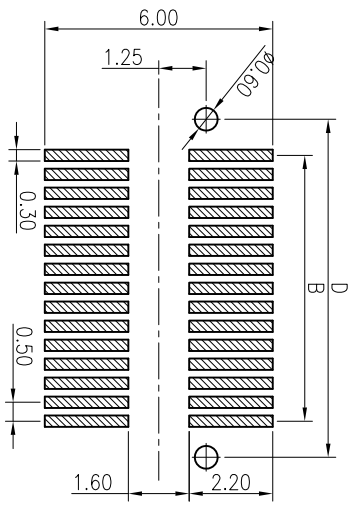
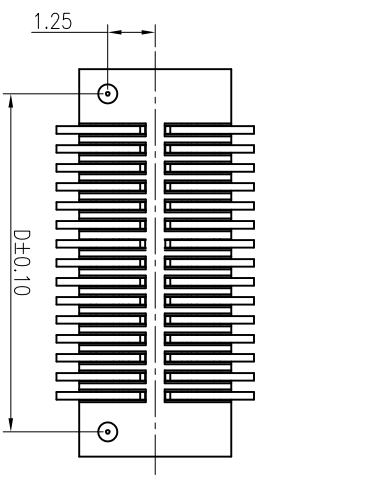

RECOMMENDED PCB PATTERN DIM.
TOLERANCE : ±0.05

No. of contacts	Dimensions				No. of contacts	Dimensions			
	A	B	C	D		A	B	C	D
2*4	4.7	1.5	2.5	3.4	2*17	11.2	8.0	9.0	19.9
2*5	5.2	2.0	3.0	3.9	2*18	11.7	8.5	9.5	20.4
2*6	5.7	2.5	3.5	4.4	2*19	12.2	9.0	10.0	20.9
2*7	6.2	3.0	4.0	4.9	2*20	12.7	9.5	10.5	21.4
2*8	6.7	3.5	4.5	5.4	2*21	13.2	10.0	11.0	21.9
2*9	7.2	4.0	5.0	5.9	2*22	13.7	10.5	11.5	22.4
2*10	7.7	4.5	5.5	6.4	2*23	14.2	11.0	12.0	22.9
2*11	8.2	5.0	6.0	6.9	2*24	14.7	11.5	12.5	23.4
2*12	8.7	5.5	6.5	7.4	2*25	15.2	12.0	13.0	23.9
2*13	9.2	6.0	7.0	7.9	2*26	15.7	12.5	13.5	24.4
2*14	9.7	6.5	7.5	8.4	2*27	16.2	13.0	14.0	24.9
2*15	10.2	7.0	8.0	8.9	2*28	16.7	13.5	14.5	25.4
2*16	10.7	7.5	8.5	9.4	2*29	17.2	14.0	15.0	25.9
2*17	11.2	8.0	9.0	9.9	2*30	17.7	14.5	15.5	26.4

CUSTOMER
TRONTEK TECHNOLOGY CO., LTD.
鉅創科技有限公司

REV:	B	SIZE:	A4	GENERAL TOLERANCE:	UNLESS OTHERWISE SPECIFIED	PART NO:	BB161-GXX-XOR
UNIT:	mm	SCALE:	5:1				
SHEET NO:	1	OF	1	TITLE:	0.5 BOARD TO BOARD SMT V/T TYPE FEMALE		
ANG:	0°30'	DRAWN BY:	Kovvin	CHECKED BY:		APPROVED BY:	
DATE:	02.18.14						